

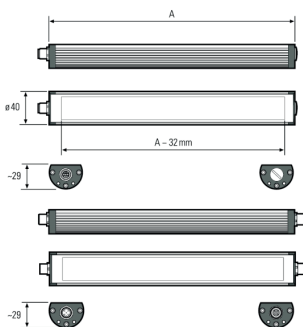

TUBELED_40 Element DC, 1540 mm, 24V DC, kaskadierbar

Artikel-Nr.:	119610-12
EAN:	4260556624419

Bestell-Nr.:	119610-12
Modell:	TUBELED_40 Element
Bauform:	LED Aufbauleuchte
Leuchtmittel:	SMD LED
Lampenleistung:	~38 W
Lampenlichtstrom:	5670 lm
Lampenlichtausbeute:	145 lm/W
Lichtverteilung:	direkt
Lichtfarbe:	Tageslichtweiß (5200 - 5700K)
Anschlusswert Leuchte:	24V DC \pm 10%
Anschluss Leuchte:	M12 A-kodiert
Schutzart:	IP54
Schutzklasse:	III
Entblendung:	Diffusor, PMMA
Abstrahlwinkel:	100°
Betriebstemperatur:	-30... +70 °C
Farbwiedergabe (Ra):	> 85
Lampenlebensdauer:	> 60.000 h
Material Gehäuse:	Aluminium, Endkappen Kunststoff
Material Abdeckung:	PMMA, gefrostet
Höhe [B] x Breite [C]:	29 mm x 40 mm
Länge [A]:	1540 mm
Gewicht:	1840 g
Bruttogewicht:	2400 g
Risikogruppe:	freie Gruppe
Kennzeichnung:	CE
Befestigungszubehör:	optional
Dimmbar:	optional über Zubehör
Gefertigt in:	Deutschland
Besonderheit:	kaskadierbar, hochtemperaturbeständig





TUBELED_40 Element DC, 1540 mm, 24V DC, cascadable

Item number: 119610-12
EAN: 4260556624419

Order number:	119610-12
Model:	TUBELED_40 Element
Type:	LED surface-mounted luminaire
Illuminant:	SMD LED
Power consumption:	~38 W
Lamp luminous flux:	5670 lm
Lamp luminous efficiency:	145 lm/W
Light distribution:	direct
Light colour:	daylight white (5200 - 5700K)
Connected load:	24V DC \pm 10%
Connection (connector):	M12 A-type encoded
Degree of protection:	IP54
Class of protection:	III
Glare-free	diffuser sheet for scattered light, PMMA
Beam angle (optics):	100°
Operating temperature:	-30... +70 °C
Colour rendering (Ra):	> 85
Lamps lifetime:	> 60,000 h
Housing material:	aluminium, endcaps made of plastics
Cover material:	PMMA, frosted
Height [B] x Width [C]:	29 mm x 40 mm
Length [A]:	1540 mm
Weight (net):	1840 g
Gross weight:	2400 g
Risk group (DIN EN 62471):	free group
Marking:	CE
Mounting accessories:	optional
Dimmable:	via optional accessory
Made in:	Germany
Feature:	cascadable, resistant to high temperatures

